

A New design of column speaker, is for indoor speaker, and it matches with interior very well. Also, the first column speaker that has the KS certification can be guaranteed high reliability and function and it provide a rich quality sound so it fit to multiple usage building such as department store.



FEATURES

- Full-range driver
- Using of high quality matching transformer
 - * Wire type
 - * Rotary switch type(Europe and US only)
- Light gray color for matching with interior
- User based design for fast installation
- Direction adjustable with bracket

SPECIFICATION

Model	CU-410F	CU-420F	CU-420F (Europe, US)	CU-430F	CU-440F	CU-440F (Europe, US)
Type	Single 4" Full-range Column Speaker	Dual 4" Full-range Column Speaker	Dual 4" Full-range Column Speaker	Triple 4" Full-range Column Speaker	Quad 4" Full-range Column Speaker	Quad 4" Full-range Column Speaker
Unit	4"					
Power Handling (AES)	10W	20W	20W	30W	40W	40W
Input Power	100V	10/5W	20/10W	20/10/5W	30/15W	40/20W
	70V	-	20/10/5W	-	-	40/20/10W
Impedance	100V	1k/2kΩ	500/1kΩ	500/1k/2kΩ	330/660Ω	250/500Ω
	70V	-	250/500/1kΩ	-	-	250/500/1kΩ
	LOW	-				
Power Selection	By Wiring		Rotary Switch	By Wiring		Rotary Switch
Frequency Response (-10dB)	180Hz ~ 14kHz	180Hz ~ 14kHz	170Hz ~ 12kHz	180Hz ~ 14kHz	180Hz ~ 14kHz	175Hz ~ 10kHz
Sensitivity (1W/1m 300,400,500,600Hz avg.)	91dB	94dB	96dB	95dB	95dB	100dB
Maximum SPL[Cont.]	101dB	107dB	109dB	110dB	111dB	116dB
Norminal Dispersion (1kHz, H x V)	90° x 100°	60° x 60°	60° x 60°	50° x 60°	90° x 40°	90° x 40°
Input Connector	Bi-Wired INPUT Line Direct Connection					
Enclosure Material	AL Body/ABS top, bottom Cover					
Enclosure Color	Light Gray					
Grill Material	Metal Grill					
Grill Color	Light Gray					
Weight (Net)	1.97kg	3.1kg	2.81kg	3.9kg	4.7kg	4.4kg
Dimensions (Net, WxHxD, mm)	156 x 300 x 129	156 x 400 x 129	156 x 400 x 129	156 x 500 x 129	156 x 600 x 129	156 x 600 x 129
Weather Resistant	IP34		-	IP34		-
Flame Resistant	O					
Certification	-					
Included Accessories	Wall Bracket					

CU-410F/420F/430F/440F

Column
Speaker

THE EXAMPLE OF SPEAKER CONNECTION

[Wire type]

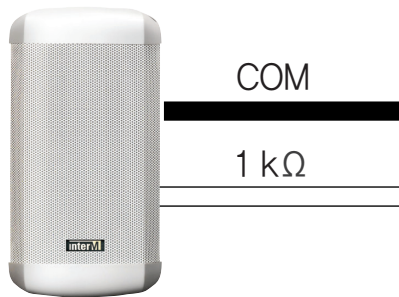

10 W

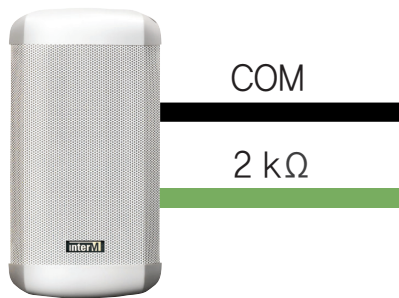

5 W

[Rotary switch type]



CU-420F



CU-440F

DIMENSION

DIMENSION

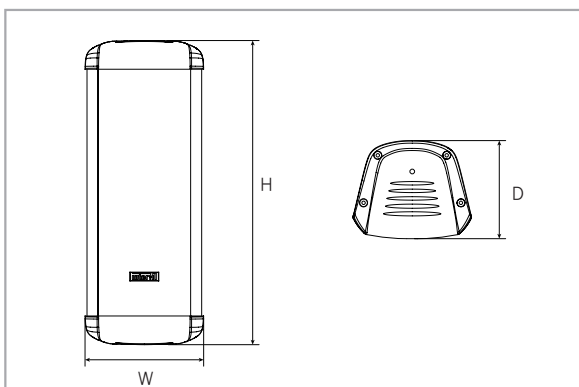

Model	W(Width) mm	H(Length) mm	D(Depth) mm
CU-410F	156	300	129
CU-420F		400	
CU-430F		500	
CU-440F		600	

TECHNICAL DATA

FREQUENCY RANGE

• CU-410F

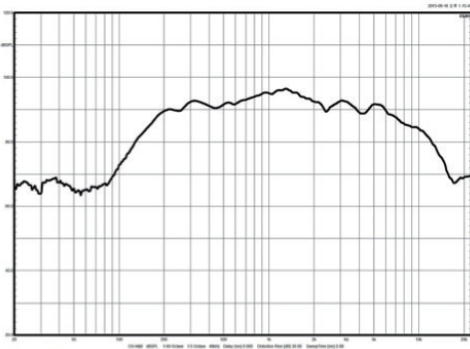

POLAR PATTERN (1kHz)

Horizontal

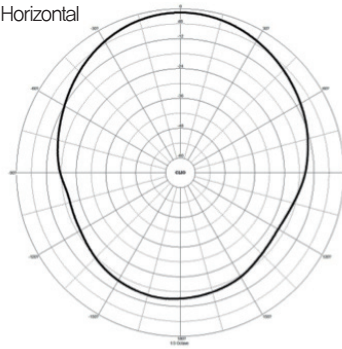

Vertical

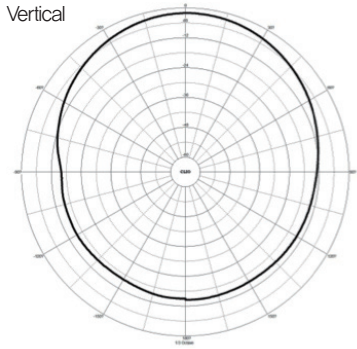

• CU-420F

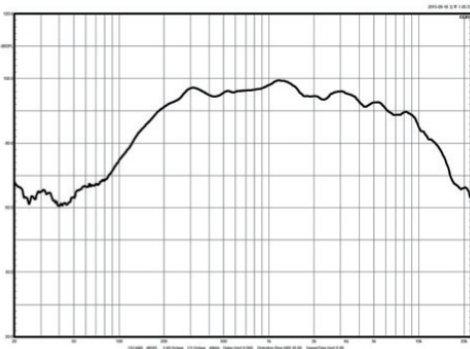

Horizontal

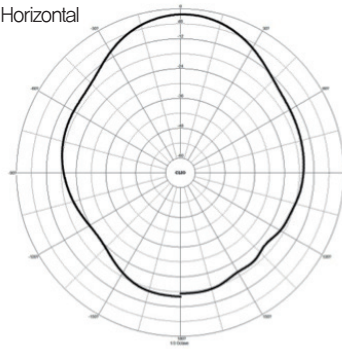

Vertical

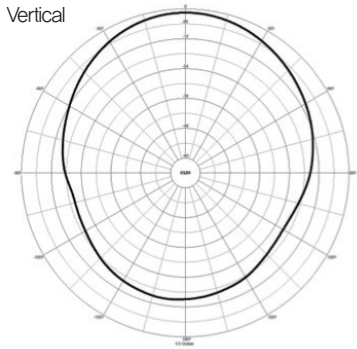

• CU-430F

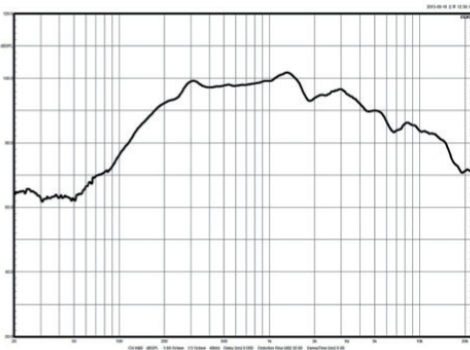

Horizontal

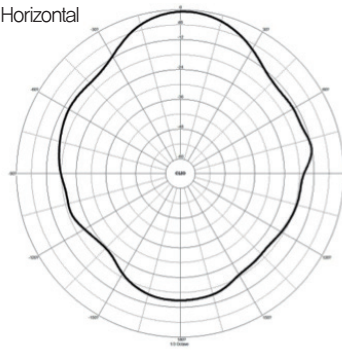

Vertical

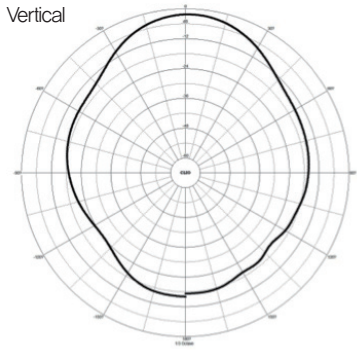

• CU-440F

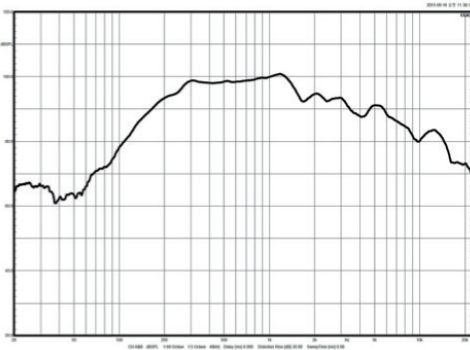

Horizontal

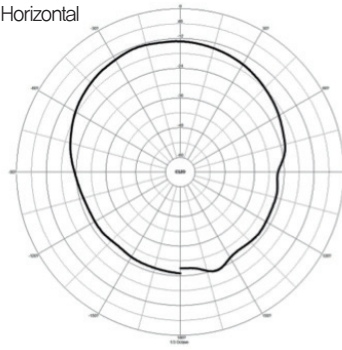

Vertical

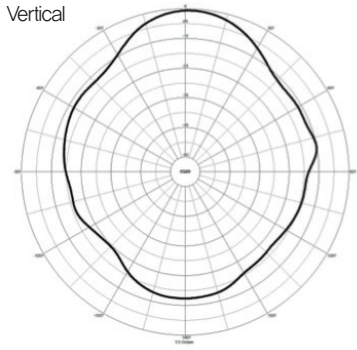

CU-410F/420F/430F/440F

Column
Speaker

TECHNICAL DATA

SPEAKER INSTALLATION GUIDE

After unpacking your CU-410F/420F/430F/440F Indoor Column Speaker, attach the speaker to a wall or other secure surface with the supplied mounting bracket. The illustration below shows the preferred method of securing the speaker.

